

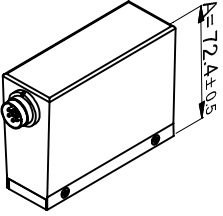

<p>1 (Scale 1:4)</p> 	<p>2 (Scale 1:4)</p> 	<p>3 (Scale 1:4)</p> 	<p>4 (Scale 1:4)</p> 
M+W analog case assy	M+W analog case assy with display	M+W analog case assy with V/F convertor	M+W analog case assy including potentiometer

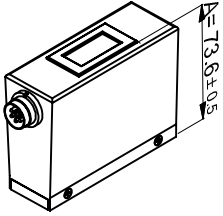
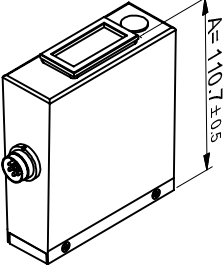
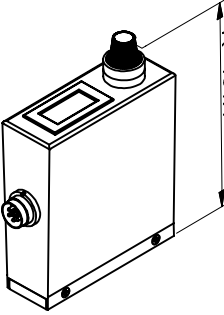
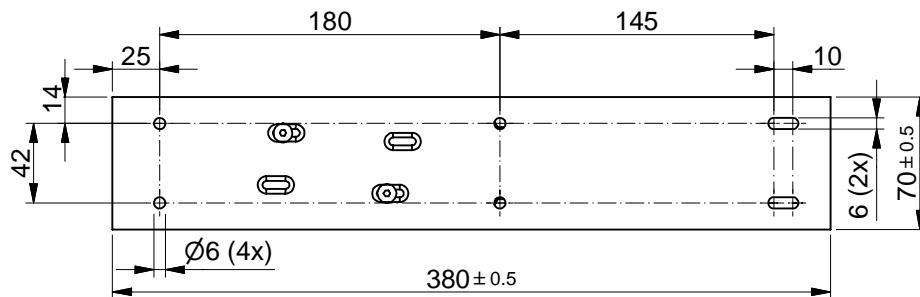
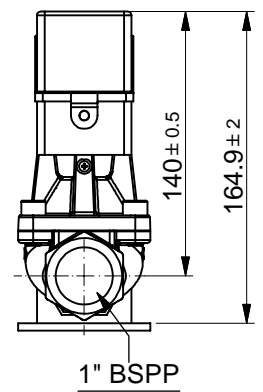
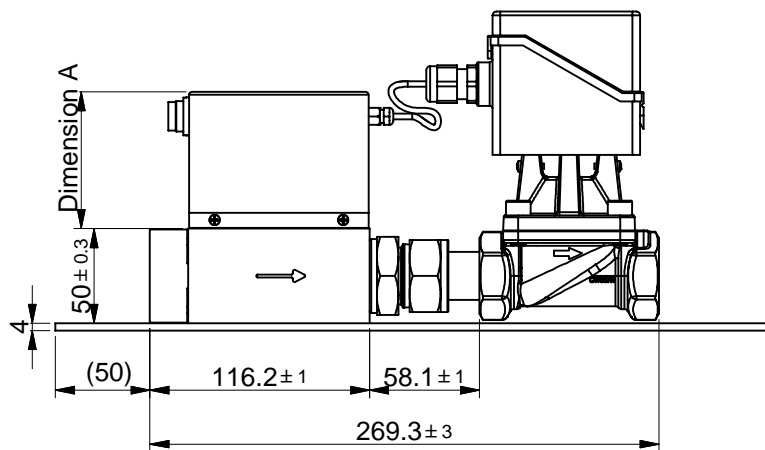
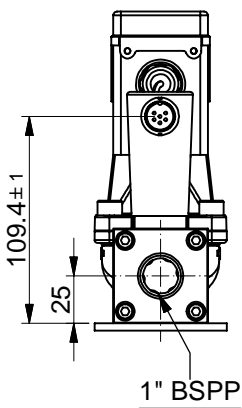
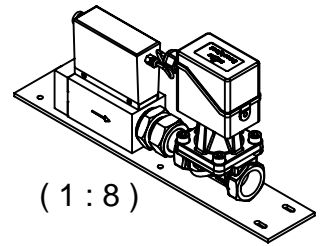

Dimensions subject to change without notice.

Tolerances ±0.2 unless otherwise mentioned

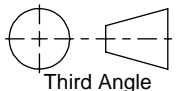
<p>Title: Dimensional drawing M+W D-6270 / BJ 1"</p>	<p>Drawer : M.B. Date: 20-08-2009</p>	<p>Revision Description: New drawing</p>	
 <p>WWW.MW-INSTRUMENTS.COM</p>	<p>Projection: Third Angle</p>  <p>Dimensions: Metric (mm)</p>	<p>Checked : Date: 20-08-2009</p> <p>Drawing no.: 7.05.769</p>	<p>Was voorheen dc 2009050610</p> <p>Rev. by: M.B. Scale: 1:4 A4</p> <p>Rev.: A Page: 1-1</p>