

One of these digital case assemblies replaces the case assembly as drawn in the dimensional drawing.
Please note that the width increases when a connector is used.

analog / RS232

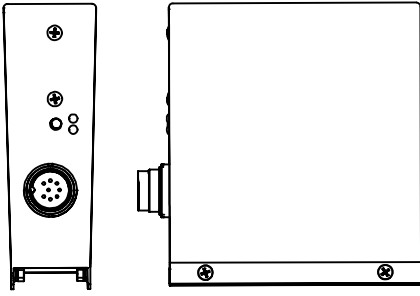

FLOW-BUS / DeviceNet / Modbus

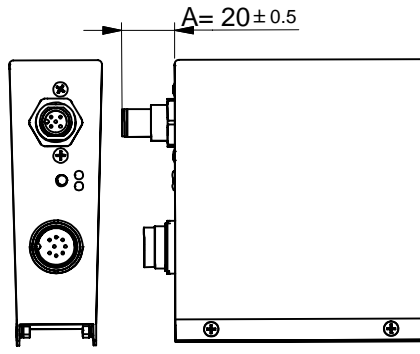

PROFIBUS

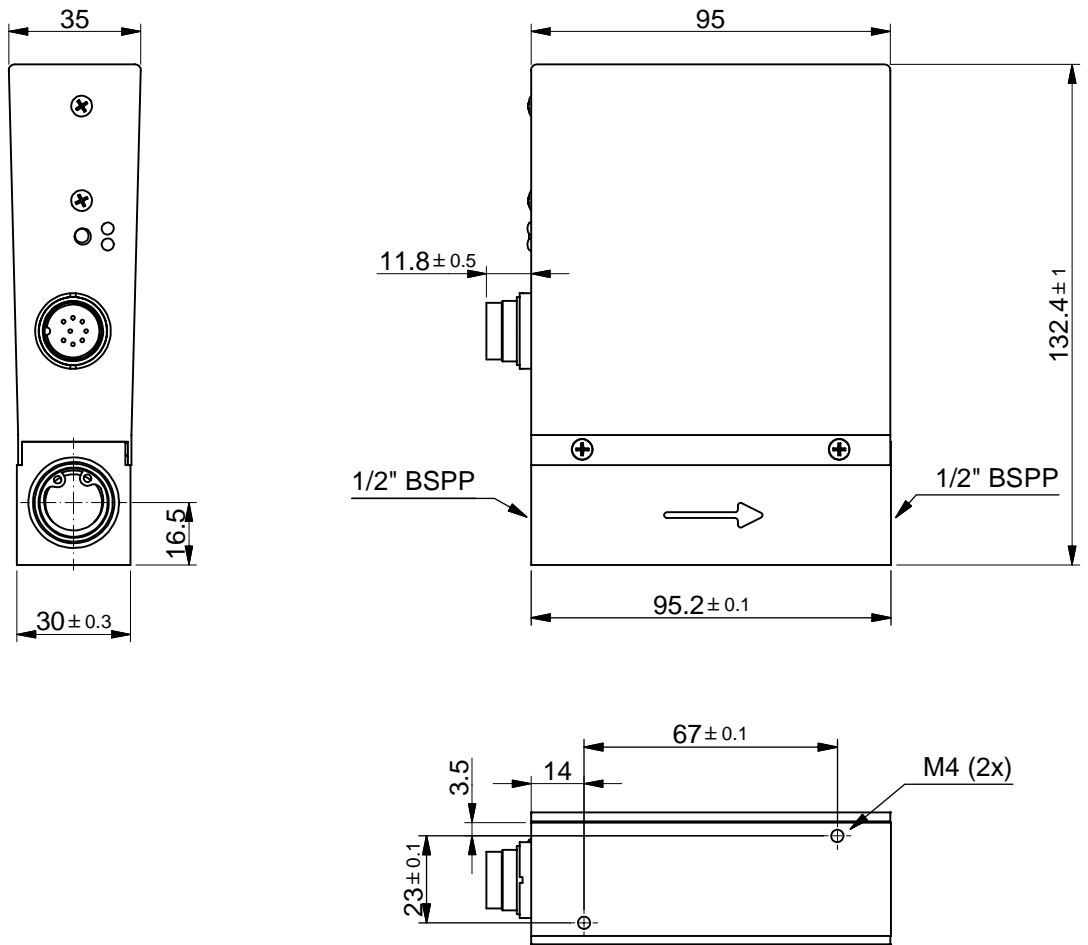
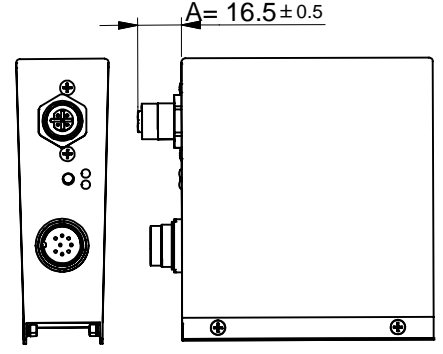

Dimensions subject to change without notice.

Tolerances ± 0.2 unless otherwise mentioned

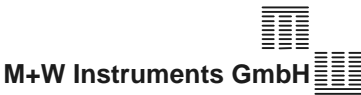
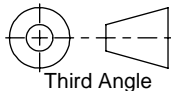
Title: Dimensional drawing M+W D-6250 DMFM		Drawer : M.B. Date: 08-05-2008	Revision Description: New drawing	
 M+W Instruments GmbH WWW.MW-INSTRUMENTS.COM	Projection:  Third Angle	Checked : Date: 13-05-2008	Rev. by:	Scale: 1:2
	Dimensions: Metric (mm)	Drawing no.: 7.05.705	Rev.: A	A4 Page: 1-1