

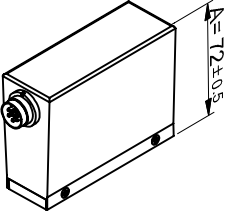

| | | | |
|--|--|---|--|
| <p>1 (Scale 1:4)</p>  | <p>2 (Scale 1:4)</p>  | <p>3 (Scale 1:4)</p>  | <p>4 (Scale 1:4)</p>  |
| <p>M+W analog case assy</p> | <p>M+W analog case assy with display</p> | <p>M+W analog case assy with V/F convertor</p> | <p>M+W analog case assy including potentiometer</p> |

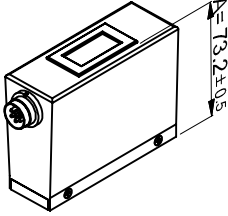
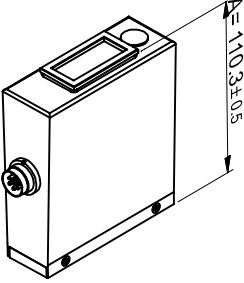
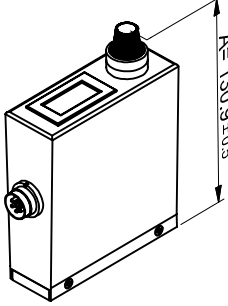
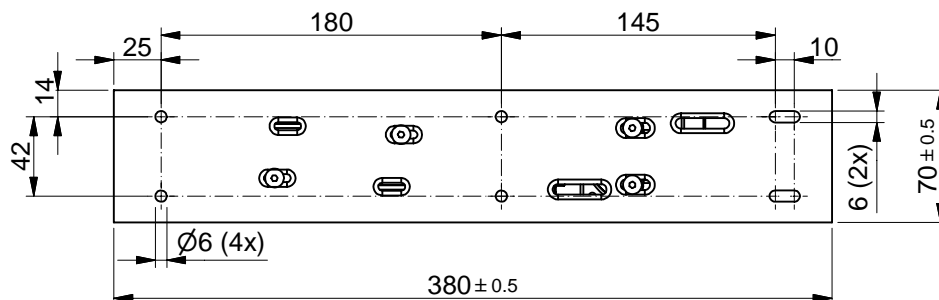
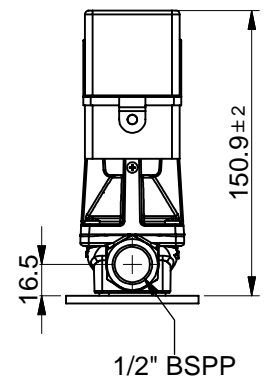
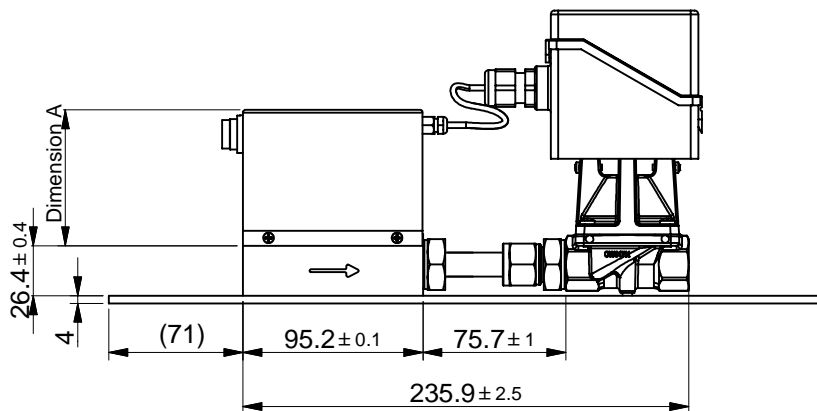
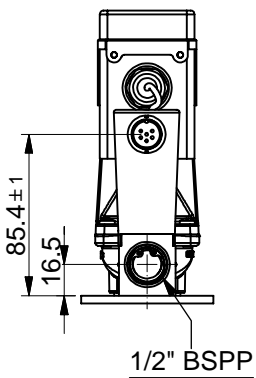
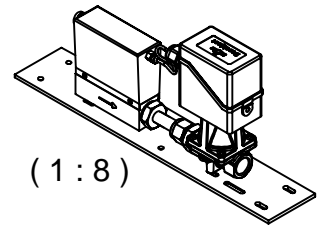

Dimensions subject to change without notice.

Tolerances ±0.2 unless otherwise mentioned

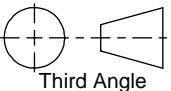
| | | | | | |
|--|---|---|--|---|--|
| <p>Title: Dimensional drawing M+W D-6251 / BJ1/2"</p> | | <p>Drawer : M.B. Date: 20-08-2009</p> | <p>Revision Description: New drawing.</p> | | |
|  <p>WWW.MW-INSTRUMENTS.COM</p> | <p>Projection: Third Angle</p>  <p>Dimensions: Metric (mm)</p> | | <p>Checked : Date: 20-08-2009</p> <p>Drawing no.: 7.05.767</p> | <p>Was voorheen dc 2009050608 Rev. by: M.B.</p> | <p>Scale: 1:4 A4 Rev.: A Page: 1-1</p> |